

100V N-Ch Power MOSFET

Feature

- ◇ High Speed Power Switching
- ◇ Enhanced Body diode dv/dt capability
- ◇ Enhanced Avalanche Ruggedness
- ◇ 100% UIS Tested, 100% Rg Tested
- ◇ Lead Free

Application

- ◇ Synchronous Rectification in SMPS
- ◇ Hard Switching and High Speed Circuit
- ◇ Power Tools
- ◇ UPS
- ◇ Motor Control

V_{DS}	100	V
$R_{DS(on),typ}$	22	m Ω
I_D	31	A

TO-220

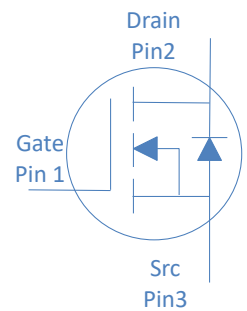

Part Number	Package	Marking
HGP230N10A	TO-220	GP230N10A

Absolute Maximum Ratings at $T_j=25^\circ\text{C}$ (unless otherwise specified)

Parameter	Symbol	Conditions	Value	Unit
Continuous Drain Current	I_D	$T_C=25^\circ\text{C}$	31	A
		$T_C=100^\circ\text{C}$	22	
Drain to Source Voltage	V_{DS}	-	100	V
Gate to Source Voltage	V_{GS}	-	± 20	V
Pulsed Drain Current	I_{DM}	-	100	A
Avalanche Energy, Single Pulse	E_{AS}	$L=0.4\text{mH}, T_C=25^\circ\text{C}$	20	mJ
Power Dissipation	P_D	$T_C=25^\circ\text{C}$	52	W
Operating and Storage Temperature	T_J, T_{stg}	-	-55 to 175	$^\circ\text{C}$

Absolute Maximum Ratings

Parameter	Symbol	Max	Unit
Thermal Resistance Junction-Case	$R_{\theta JC}$	2.9	$^\circ\text{C/W}$
Thermal Resistance Junction-Ambient	$R_{\theta JA}$	60	$^\circ\text{C/W}$

Electrical Characteristics at $T_j=25^\circ\text{C}$ (unless otherwise specified)
Static Characteristics

Parameter	Symbol	Conditions	Value			Unit
			min	typ	max	
Drain to Source Breakdown Voltage	$V_{(BR)DSS}$	$V_{GS}=0V, I_D=250\mu A$	100	-	-	V
Gate Threshold Voltage	$V_{GS(th)}$	$V_{GS}=V_{DS}, I_D=250\mu A$	2	3	4	
Zero Gate Voltage Drain Current	I_{DSS}	$V_{GS}=0V, V_{DS}=100V, T_j=25^\circ\text{C}$	-	-	1	μA
		$V_{GS}=0V, V_{DS}=100V, T_j=100^\circ\text{C}$	-	-	100	
Gate to Source Leakage Current	I_{GSS}	$V_{GS}=\pm 20V, V_{DS}=0V$	-	-	± 100	nA
Drain to Source on Resistance	$R_{DS(on)}$	$V_{GS}=10V, I_D=10A$	-	22	25	$m\Omega$
Transconductance	g_{fs}	$V_{DS}=5V, I_D=10A$	-	19	-	S
Gate Resistance	R_G	$V_{GS}=0V, V_{DS}$ Open, $f=1\text{MHz}$	-	1.7	-	Ω

Dynamic Characteristics

Input Capacitance	C_{iss}	$V_{GS}=0V, V_{DS}=50V, f=1\text{MHz}$	-	723	-	pF
Output Capacitance	C_{oss}		-	107	-	
Reverse Transfer Capacitance	C_{rss}		-	7.6	-	
Total Gate Charge	Q_g	$V_{DD}=50V, I_D=10A, V_{GS}=10V$	-	11	-	nC
Gate to Source Charge	Q_{gs}		-	3	-	
Gate to Drain (Miller) Charge	Q_{gd}		-	3	-	
Turn on Delay Time	$t_{d(on)}$	$V_{DD}=50V, I_D=10A, V_{GS}=10V, R_G=10\Omega,$	-	6	-	ns
Rise time	t_r		-	3	-	
Turn off Delay Time	$t_{d(off)}$		-	10	-	
Fall Time	t_f		-	3	-	

Reverse Diode Characteristics

Diode Forward Voltage	V_{SD}	$V_{GS}=0V, I_F=20A$	-	0.9	1.2	V
Reverse Recovery Time	t_{rr}	$V_R=50V, I_F=10A, dI_F/dt=500A/\mu s$	-	33	-	ns
Reverse Recovery Charge	Q_{rr}		-	132	-	nC

Fig 1. Typical Output Characteristics

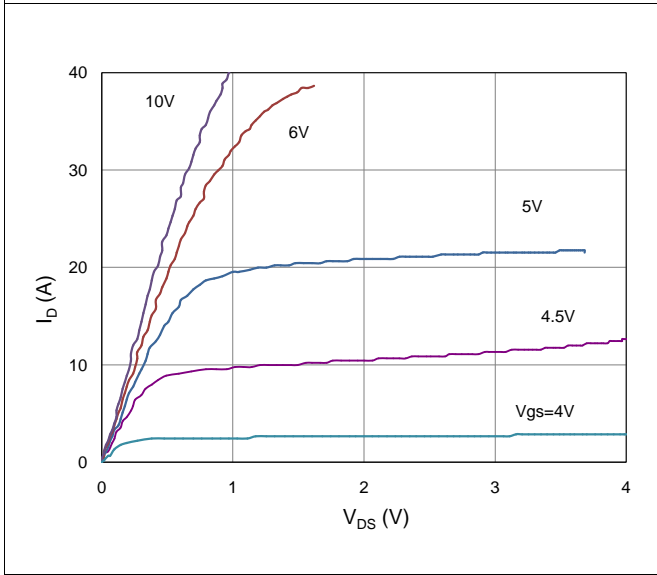

Figure 2. On-Resistance vs. Gate-Source Voltage

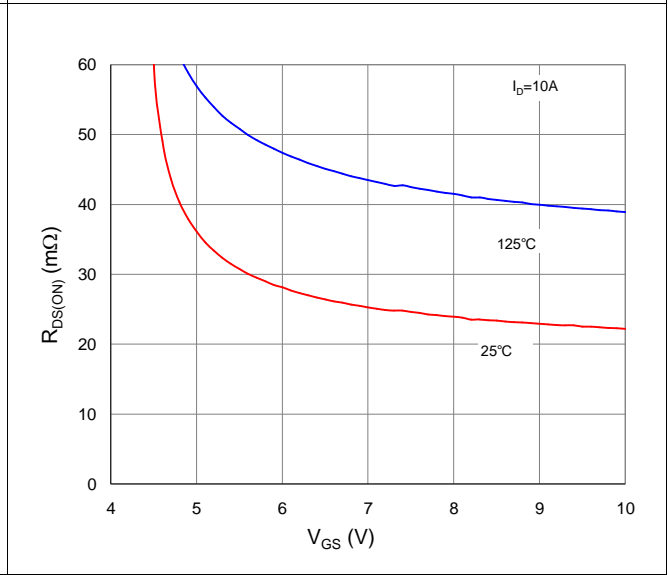

Figure 3. On-Resistance vs. Drain Current and Gate Voltage

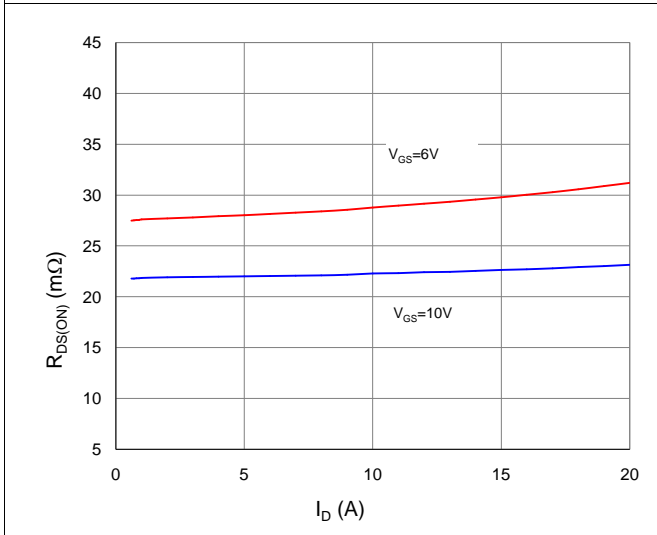

Figure 4. Normalized On-Resistance vs. Junction Temperature

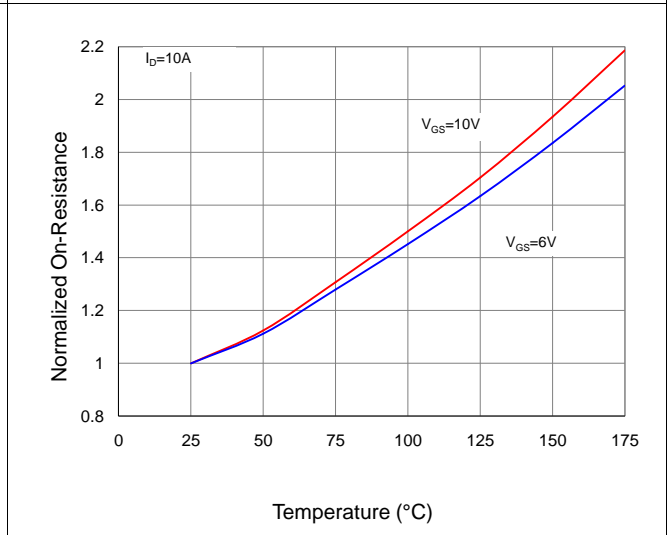

Figure 5. Typical Transfer Characteristics

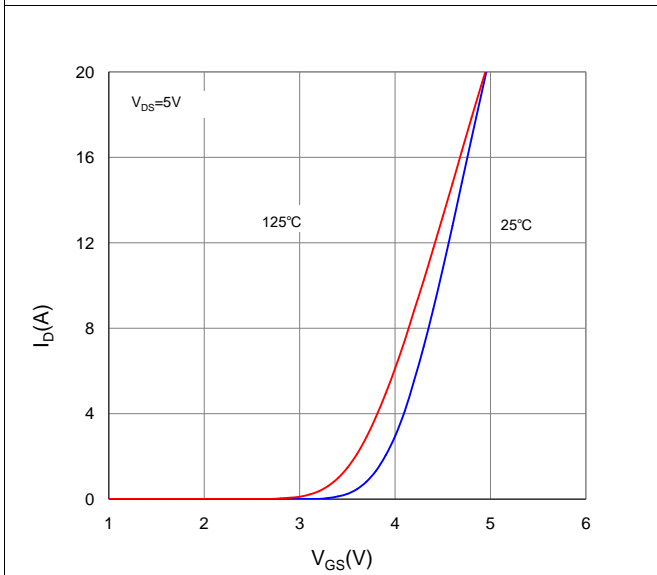

Figure 6. Typical Source-Drain Diode Forward Voltage

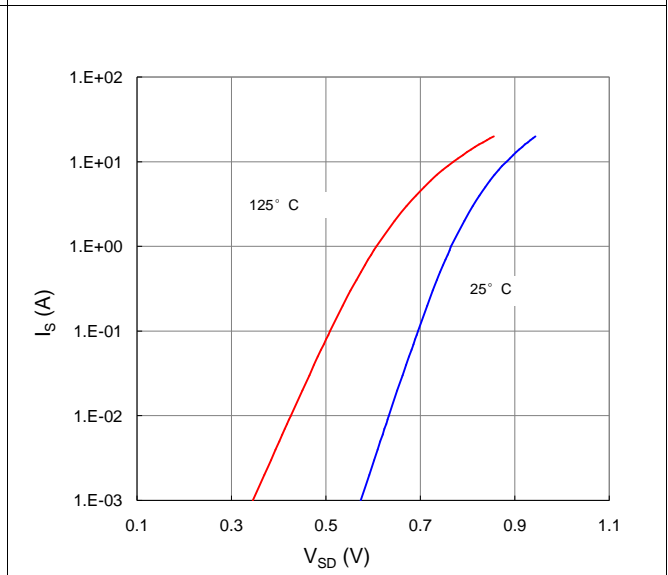

Figure 7. Typical Gate-Charge vs. Gate-to-Source Voltage

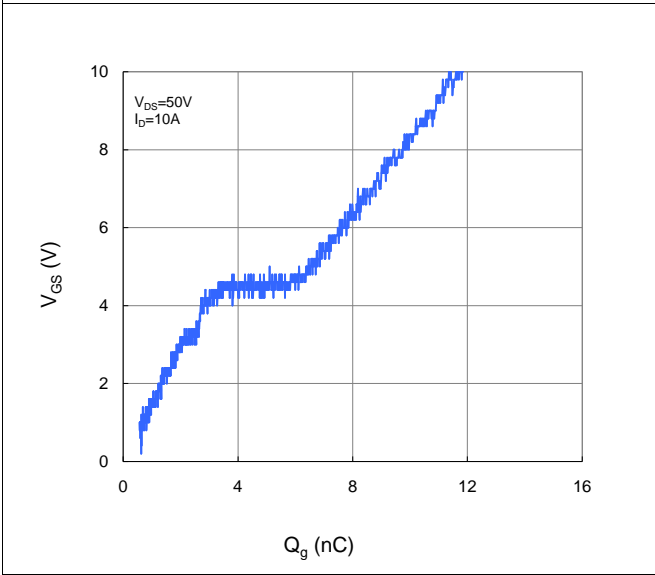

Figure 8. Typical Capacitance vs. Drain-to-Source Voltage

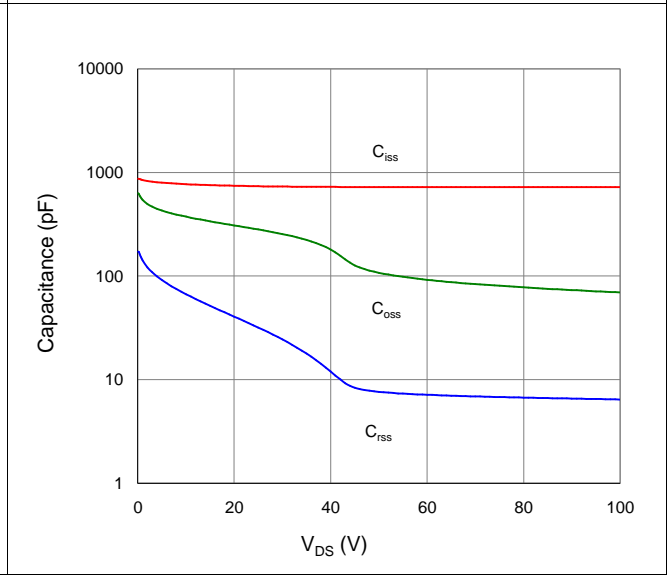

Figure 9. Maximum Safe Operating Area

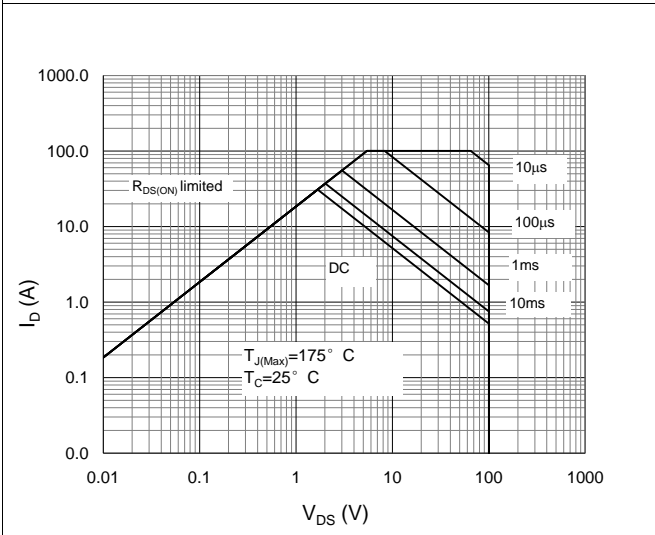

Figure 10. Maximum Drain Current vs. Case Temperature

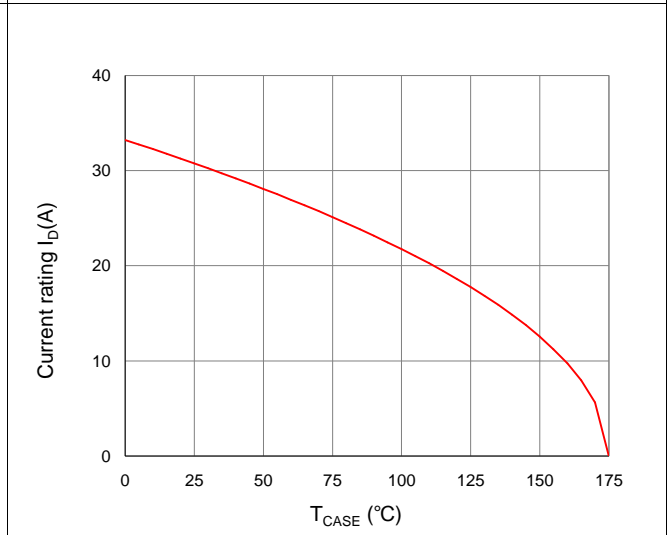
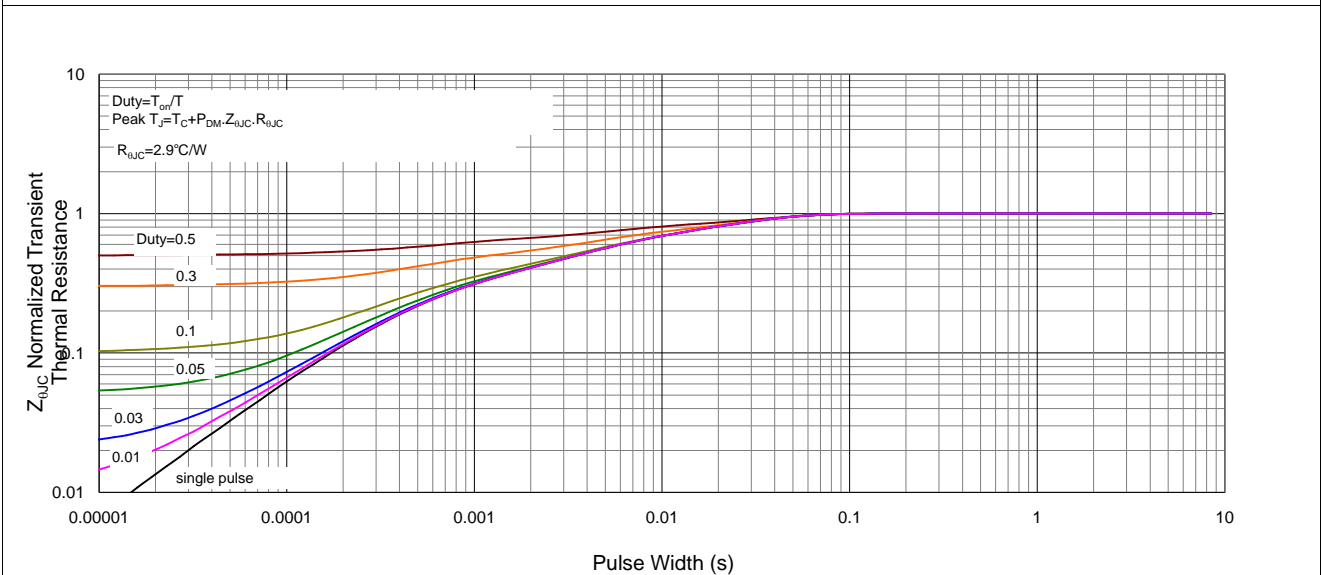
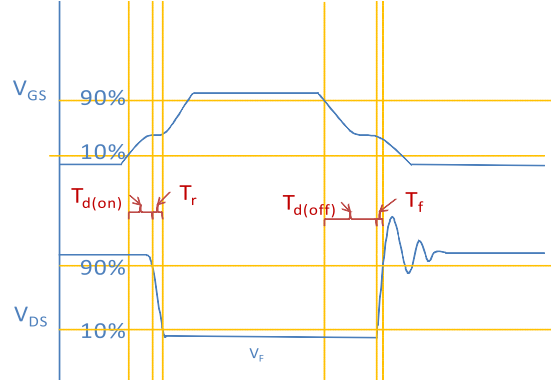
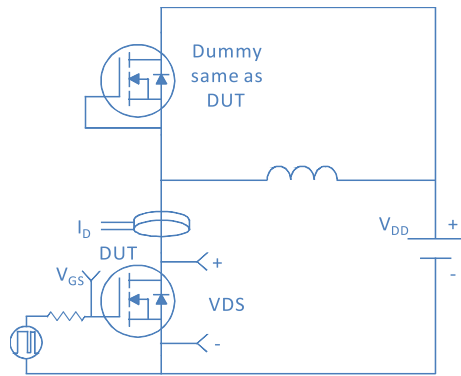

Figure 11. Normalized Maximum Transient Thermal Impedance, Junction-to-Case



Inductive switching Test



Gate Charge Test

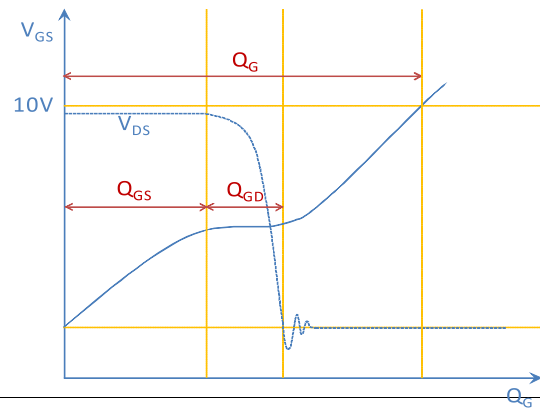
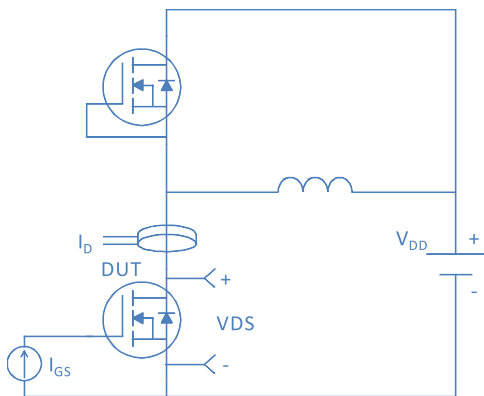

Unclamped Inductive Switching (UIS) Test

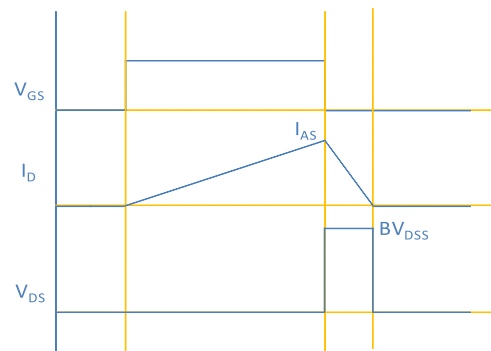
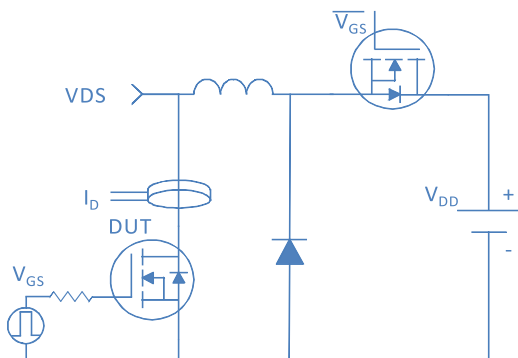

Diode Recovery Test

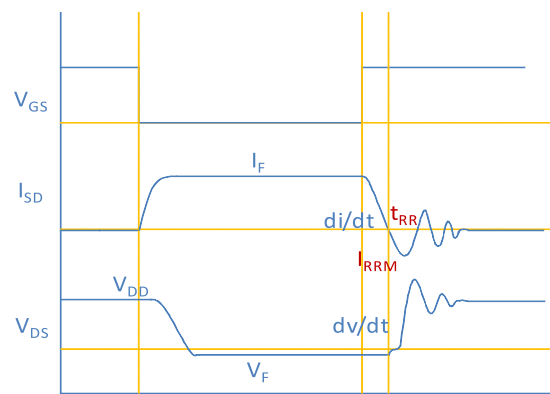
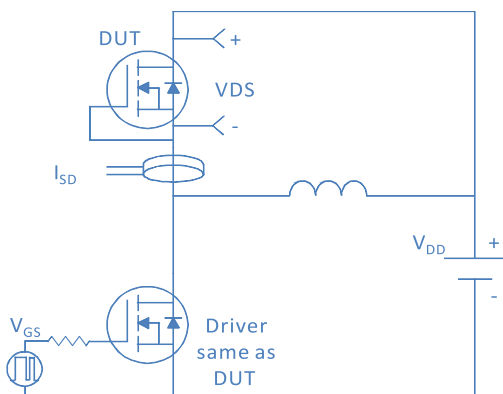

TO-220, 3 leads

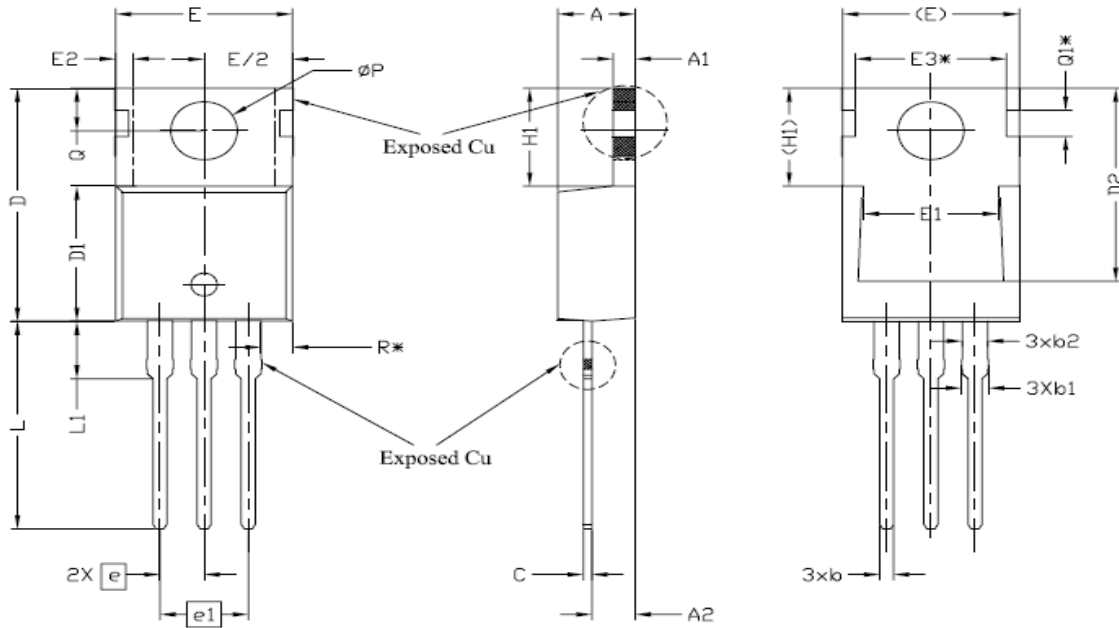

SYMBOL	DIMENSIONS			NOTES
	MIN.	NOM.	MAX.	
A	4,24	4,44	4,64	
A1	1,15	1,27	1,40	
A2	2,30	2,48	2,70	
b	0,70	0,80	0,90	
b1	1,20	1,55	1,75	
b2	1,20	1,45	1,70	
c	0,40	0,50	0,60	
D	14,70	15,37	16,00	4
D1	8,82	8,92	9,02	
D2	12,63	12,73	12,83	5
E	9,96	10,16	10,36	4,5
E1	6,86	7,77	8,89	5
E2	-	-	0,76	6
E3*	8,70REF.			
e	2,54BSC			
e1	5,08BSC			
H1	6,30	6,45	6,60	5,6
L	13,47	13,72	13,97	
L1	3,60	3,80	4,00	
ØP	3,75	3,84	3,93	
Q	2,60	2,80	3,00	
Q1*	1,73REF.			
R*	1,62REF.			